

Click to view price, real time Inventory,
Delivery & Lifecycle Information ;

TSOP4856

Vishay Semiconductors

Infrared Receivers 4.5-5.5V 56kHz

Any questions, please feel free to contact us.

info@kaimte.com

IR Receiver Modules for Remote Control Systems

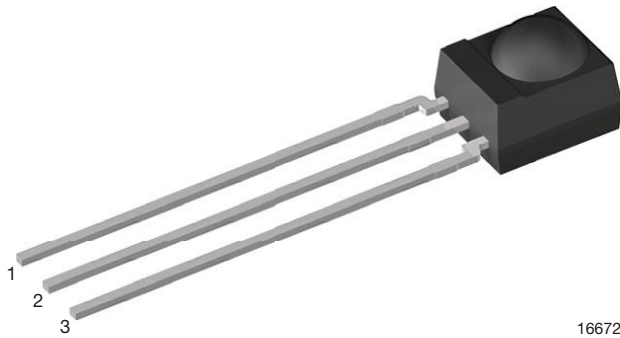

DESIGN SUPPORT TOOLS

[click logo to get started](#)

MECHANICAL DATA

Pinning for TSOP44.., TSOP48..:

 1 = OUT, 2 = GND, 3 = V_S

Pinning for TSOP22.., TSOP24..:

 1 = OUT, 2 = V_S, 3 = GND

FEATURES

- Improved immunity against HF and RF noise
- Low supply current
- Photo detector and preamplifier in one package
- Internal filter for PCM frequency
- Supply voltage: 2.5 V to 5.5 V
- Improved immunity against optical noise
- Insensitive to supply voltage ripple and noise
- Material categorization:

 for definitions of compliance please see www.vishay.com/doc?99912

DESCRIPTION

The TSOP22.., TSOP48.., TSOP24.. and TSOP44.. series are miniaturized IR receiver modules for infrared remote control systems. A PIN diode and a preamplifier are assembled on lead frame, the epoxy package contains an IR filter.

The demodulated output signal can be directly connected to a microprocessor for decoding.

The TSOP24.., TSOP44.. series devices are optimized to suppress almost all spurious pulses from Wi-Fi and CFL sources. They may suppress some data signals if continuously transmitted.

The TSOP22.., TSOP48.. series devices are provided primarily for compatibility with old AGC2 designs. New designs should prefer the TSOP24.., TSOP44.. series containing the newer AGC4.

These components have not been qualified according to automotive specifications.

| PARTS TABLE | | | | | |
|-------------------|--------|---|---------------------------------------|---|---------------------------------------|
| AGC | | LEGACY, FOR LONG BURST REMOTE CONTROLS (AGC2) | | RECOMMENDED FOR LONG BURST CODES (AGC4) | |
| Carrier frequency | 30 kHz | TSOP4830 | TSOP2230 | TSOP4430 | TSOP2430 |
| | 33 kHz | TSOP4833 | TSOP2233 | TSOP4433 | TSOP2433 |
| | 36 kHz | TSOP4836 | TSOP2236 | TSOP4436 ⁽¹⁾⁽²⁾⁽³⁾ | TSOP2436 ⁽¹⁾⁽²⁾⁽³⁾ |
| | 38 kHz | TSOP4838 | TSOP2238 | TSOP4438 ⁽⁴⁾⁽⁵⁾⁽⁶⁾ | TSOP2438 ⁽⁴⁾⁽⁵⁾⁽⁶⁾ |
| | 40 kHz | TSOP4840 | TSOP2240 | TSOP4440 | TSOP2440 |
| | 56 kHz | TSOP4856 | TSOP2256 | TSOP4456 ⁽⁶⁾⁽⁷⁾ | TSOP2456 ⁽⁶⁾⁽⁷⁾ |
| Package | | Mold | | | |
| Pinning | | 1 = OUT, 2 = GND, 3 = V _S | 1 = OUT, 2 = V _S , 3 = GND | 1 = OUT, 2 = GND, 3 = V _S | 1 = OUT, 2 = V _S , 3 = GND |
| Dimensions (mm) | | 6.0 W x 6.95 H x 5.6 D | | | |
| Mounting | | Leaded | | | |
| Application | | Remote control | | | |
| Best choice for | | ⁽¹⁾ RC-5 ⁽²⁾ RC-6 ⁽³⁾ Panasonic ⁽⁴⁾ NEC ⁽⁵⁾ Sharp ⁽⁶⁾ r-step ⁽⁷⁾ Thomson RCA | | | |

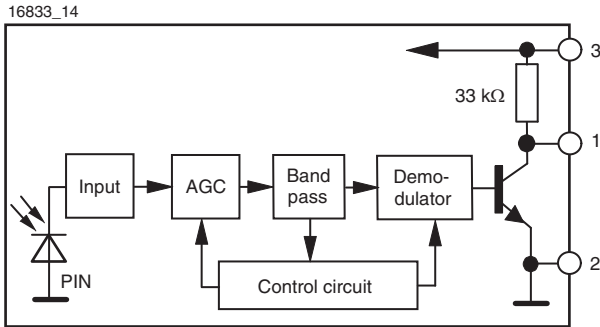
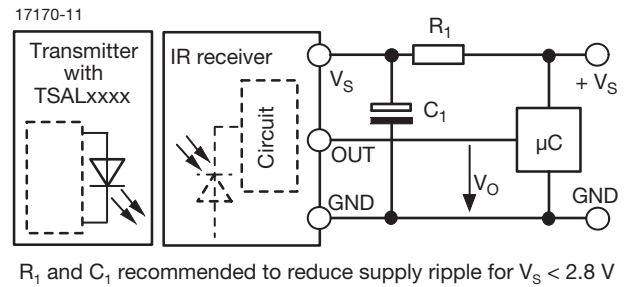
BLOCK DIAGRAM

APPLICATION CIRCUIT

ABSOLUTE MAXIMUM RATINGS

| PARAMETER | TEST CONDITION | SYMBOL | VALUE | UNIT |
|-----------------------------|-------------------------------|-------------|-------------------------|------|
| Supply voltage | | V_S | -0.3 to +6 | V |
| Supply current | | I_S | 5 | mA |
| Output voltage | | V_O | -0.3 to 5.5 | V |
| Voltage at output to supply | | $V_S - V_O$ | -0.3 to ($V_S + 0.3$) | V |
| Output current | | I_O | 5 | mA |
| Junction temperature | | T_j | 100 | °C |
| Storage temperature range | | T_{stg} | -25 to +85 | °C |
| Operating temperature range | | T_{amb} | -25 to +85 | °C |
| Power consumption | $T_{amb} \leq 85$ °C | P_{tot} | 10 | mW |
| Soldering temperature | $t \leq 10$ s, 1 mm from case | T_{sd} | 260 | °C |

Note

- Stresses beyond those listed under "Absolute Maximum Ratings" may cause permanent damage to the device. This is a stress rating only and functional operation of the device at these or any other conditions beyond those indicated in the operational sections of this specification is not implied. Exposure to absolute maximum rating conditions for extended periods may affect the device reliability

ELECTRICAL AND OPTICAL CHARACTERISTICS ($T_{amb} = 25$ °C, unless otherwise specified)

| PARAMETER | TEST CONDITION | SYMBOL | MIN. | TYP. | MAX. | UNIT |
|-----------------------|--|-----------------|------|----------|------|-------------------|
| Supply current | $E_v = 0, V_S = 5$ V | I_{SD} | 0.55 | 0.7 | 0.9 | mA |
| | $E_v = 40$ klx, sunlight | I_{SH} | - | 0.8 | - | mA |
| Supply voltage | | V_S | 2.5 | - | 5.5 | V |
| Transmission distance | $E_v = 0$, test signal see Fig. 1, IR diode TSAL6200, $I_F = 50$ mA | d | - | 24 | - | m |
| Output voltage low | $I_{OSL} = 0.5$ mA, $E_e = 0.7$ mW/m ² , test signal see Fig. 1 | V_{OSL} | - | - | 100 | mV |
| Minimum irradiance | Pulse width tolerance: $t_{pi} - 5/f_o < t_{po} < t_{pi} + 6/f_o$, test signal see Fig. 1 | E_e min. | - | 0.12 | 0.25 | mW/m ² |
| Maximum irradiance | $t_{pi} - 5/f_o < t_{po} < t_{pi} + 6/f_o$, test signal see Fig. 1 | E_e max. | 50 | - | - | W/m ² |
| Directivity | Angle of half transmission distance | $\varphi_{1/2}$ | - | ± 45 | - | deg |

TYPICAL CHARACTERISTICS ($T_{amb} = 25\text{ }^{\circ}\text{C}$, unless otherwise specified)

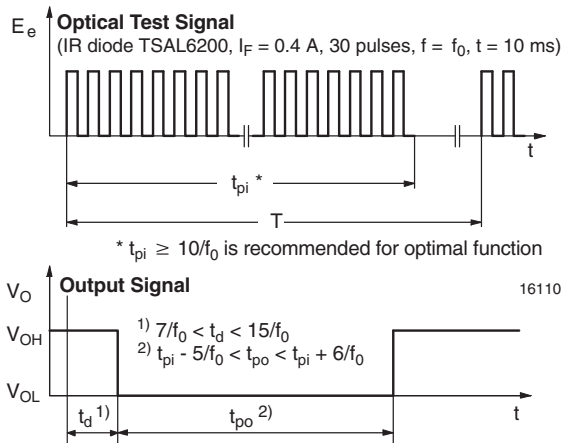

Fig. 1 - Output Active Low

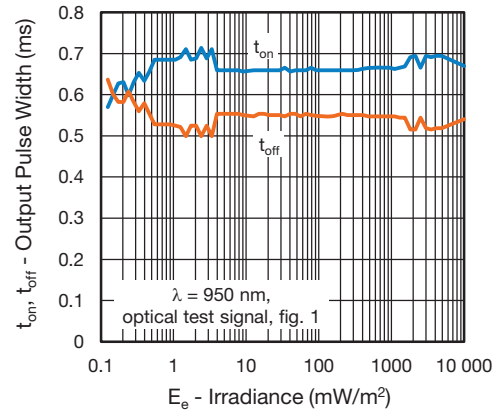

Fig. 4 - Output Pulse Diagram

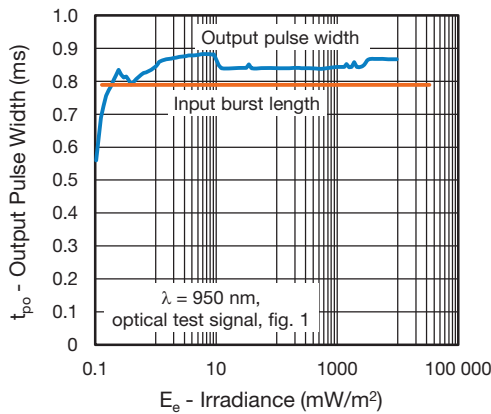

Fig. 2 - Pulse Length and Sensitivity in Dark Ambient

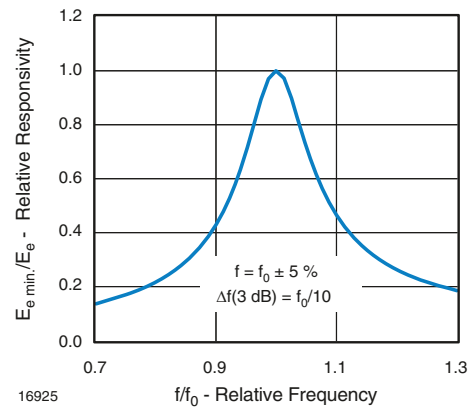

Fig. 5 - Frequency Dependence of Responsivity

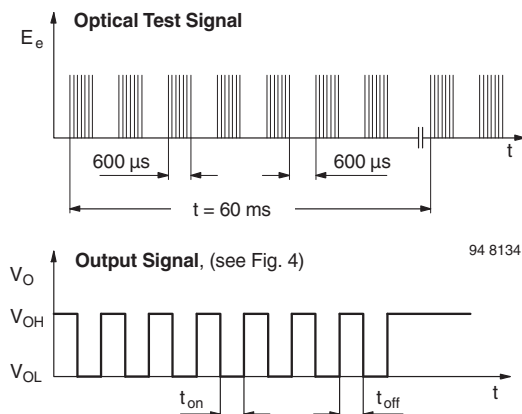

Fig. 3 - Output Function

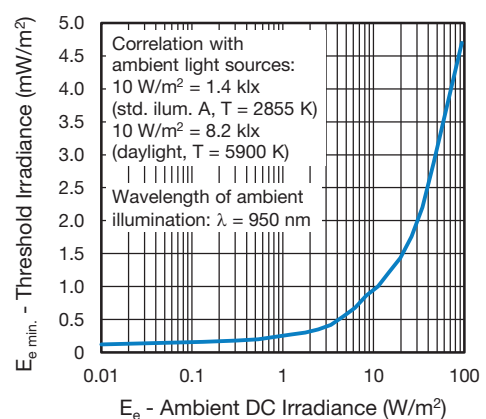

Fig. 6 - Sensitivity in Bright Ambient

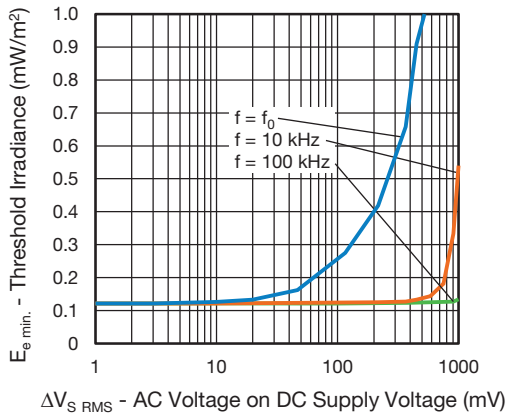

Fig. 7 - Sensitivity vs. Supply Voltage Disturbances

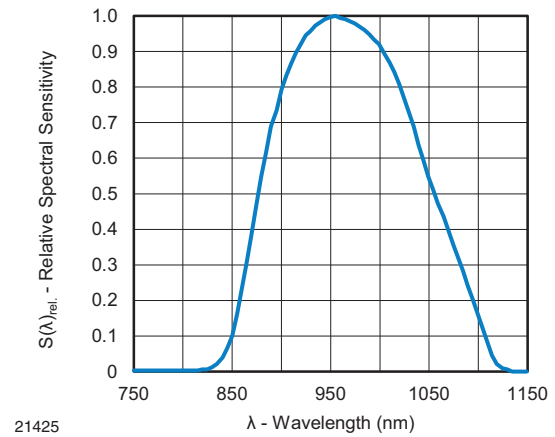

Fig. 10 - Relative Spectral Sensitivity vs. Wavelength

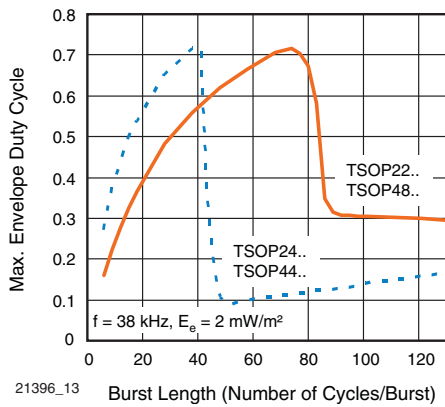

Fig. 8 - Max. Envelope Duty Cycle vs. Burst Length

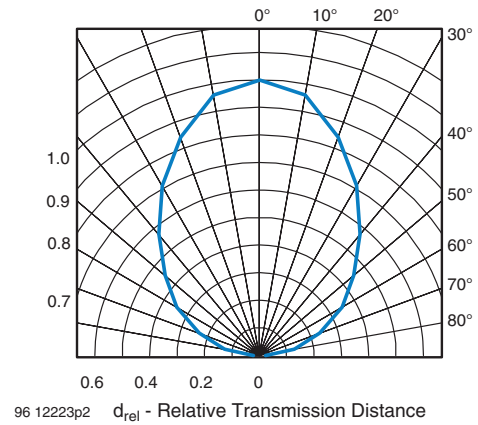

Fig. 11 - Horizontal Directivity

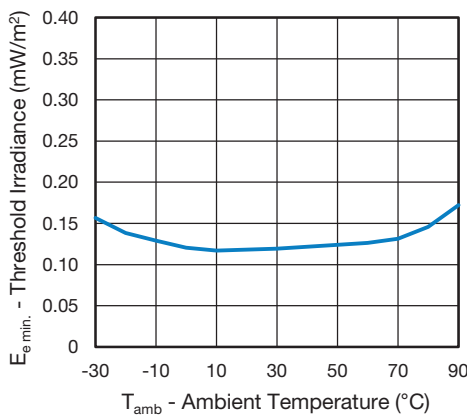

Fig. 9 - Sensitivity vs. Ambient Temperature

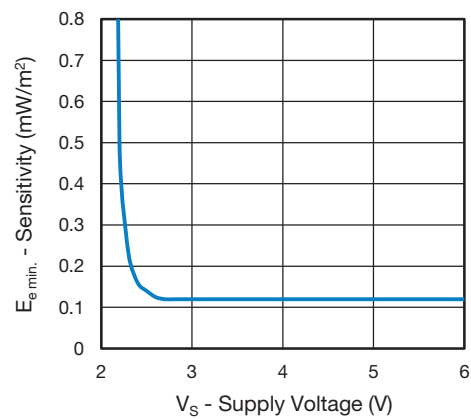

Fig. 12 - Sensitivity vs. Supply Voltage

SUITABLE DATA FORMAT

This series is designed to suppress spurious output pulses due to noise or disturbance signals. The devices can distinguish data signals from noise due to differences in frequency, burst length, and envelope duty cycle. The data signal should be close to the device's band-pass center frequency (e.g. 38 kHz) and fulfill the conditions in the table below.

When a data signal is applied to the product in the presence of a disturbance, the sensitivity of the receiver is automatically reduced by the AGC to insure that no spurious pulses are present at the receiver's output. Some examples which are suppressed are:

- DC light (e.g. from tungsten bulbs sunlight)
- Continuous signals at any frequency
- Strongly or weakly modulated patterns from fluorescent lamps with electronic ballasts (see Fig. 13 or Fig. 14).
- 2.4 GHz and 5 GHz Wi-Fi

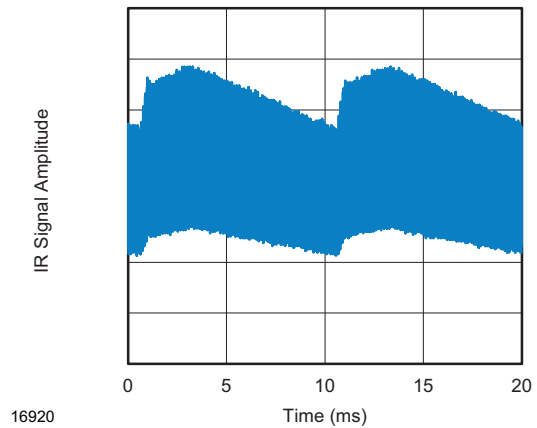

Fig. 13 - IR Disturbance from Fluorescent Lamp With Low Modulation

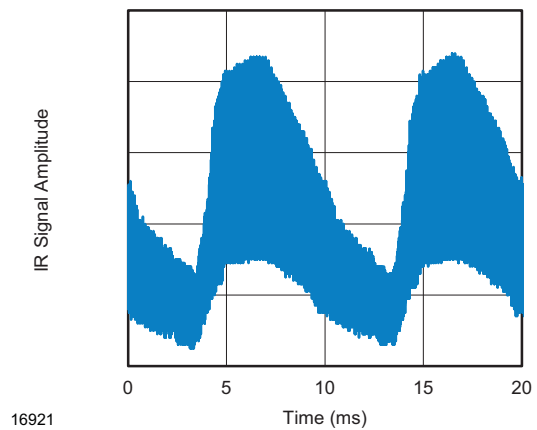

Fig. 14 - IR Disturbance from Fluorescent Lamp With High Modulation

| | TSOP22..., TSOP48.. | TSOP24..., TSOP44.. |
|--|---|---|
| Minimum burst length | 10 cycles/burst | 10 cycles/burst |
| After each burst of length a minimum gap time is required of | 10 to 70 cycles ≥ 12 cycles | 10 to 35 cycles ≥ 12 cycles |
| For bursts greater than a minimum gap time in the data stream is needed of | 70 cycles > 4 x burst length | 35 cycles > 10 x burst length |
| Maximum number of continuous short bursts/second | 800 | 1300 |
| NEC code | Yes | Preferred |
| RC5/RC6 code | Yes | Preferred |
| Thomson 56 kHz code | Yes | Preferred |
| Sharp code | Yes | Preferred |
| Suppression of interference from fluorescent lamps | Mild disturbance patterns are suppressed (example: signal pattern of Fig. 13) | Complex and critical disturbance patterns are suppressed (example: signal pattern of Fig. 14 or highly dimmed LCDs) |

Note

- For data formats with short bursts please see the datasheet of TSOP23..., TSOP43..



PACKAGE DIMENSIONS in millimeters

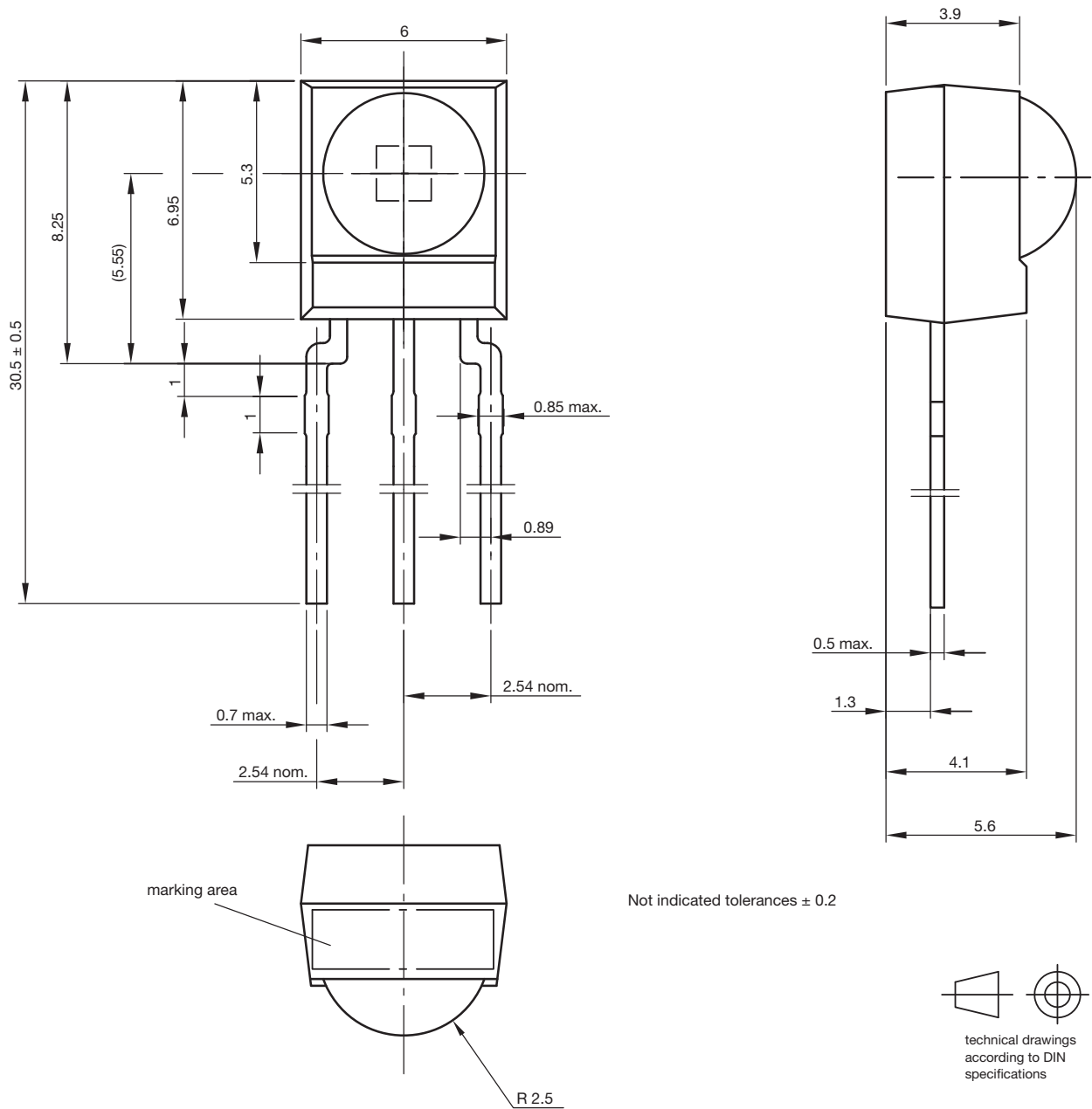

Drawing-No.: 6.550-5169.01-4
Issue: 9; 03.11.10
13655



Disclaimer

ALL PRODUCT, PRODUCT SPECIFICATIONS AND DATA ARE SUBJECT TO CHANGE WITHOUT NOTICE TO IMPROVE RELIABILITY, FUNCTION OR DESIGN OR OTHERWISE.

Vishay Intertechnology, Inc., its affiliates, agents, and employees, and all persons acting on its or their behalf (collectively, "Vishay"), disclaim any and all liability for any errors, inaccuracies or incompleteness contained in any datasheet or in any other disclosure relating to any product.

Vishay makes no warranty, representation or guarantee regarding the suitability of the products for any particular purpose or the continuing production of any product. To the maximum extent permitted by applicable law, Vishay disclaims (i) any and all liability arising out of the application or use of any product, (ii) any and all liability, including without limitation special, consequential or incidental damages, and (iii) any and all implied warranties, including warranties of fitness for particular purpose, non-infringement and merchantability.

Statements regarding the suitability of products for certain types of applications are based on Vishay's knowledge of typical requirements that are often placed on Vishay products in generic applications. Such statements are not binding statements about the suitability of products for a particular application. It is the customer's responsibility to validate that a particular product with the properties described in the product specification is suitable for use in a particular application. Parameters provided in datasheets and / or specifications may vary in different applications and performance may vary over time. All operating parameters, including typical parameters, must be validated for each customer application by the customer's technical experts. Product specifications do not expand or otherwise modify Vishay's terms and conditions of purchase, including but not limited to the warranty expressed therein.

Except as expressly indicated in writing, Vishay products are not designed for use in medical, life-saving, or life-sustaining applications or for any other application in which the failure of the Vishay product could result in personal injury or death. Customers using or selling Vishay products not expressly indicated for use in such applications do so at their own risk. Please contact authorized Vishay personnel to obtain written terms and conditions regarding products designed for such applications.

No license, express or implied, by estoppel or otherwise, to any intellectual property rights is granted by this document or by any conduct of Vishay. Product names and markings noted herein may be trademarks of their respective owners.

Mouser Electronics

Authorized Distributor

Click to View Pricing, Inventory, Delivery & Lifecycle Information:

[Vishay:](#)

[TSOP4856](#) [TSOP4840](#) [TSOP4838](#) [TSOP4830](#) [TSOP4836](#) [TSOP4833](#)